

KTest

更に上のクオリティ 更に上のサービス



問題集

<http://www.ktest.jp>

1年で無料進級することに提供する

Exam : **50-684**

Title : Novell eDirectory Tools and
Diagnostics

Version : Demo

1.You are the eDirector administrator for the DigitalAir-Tree tree. You would like to move some containers in your tree to align the tree structure more closely to the physical structure of your organization. Given the information in the exhibits, without manually

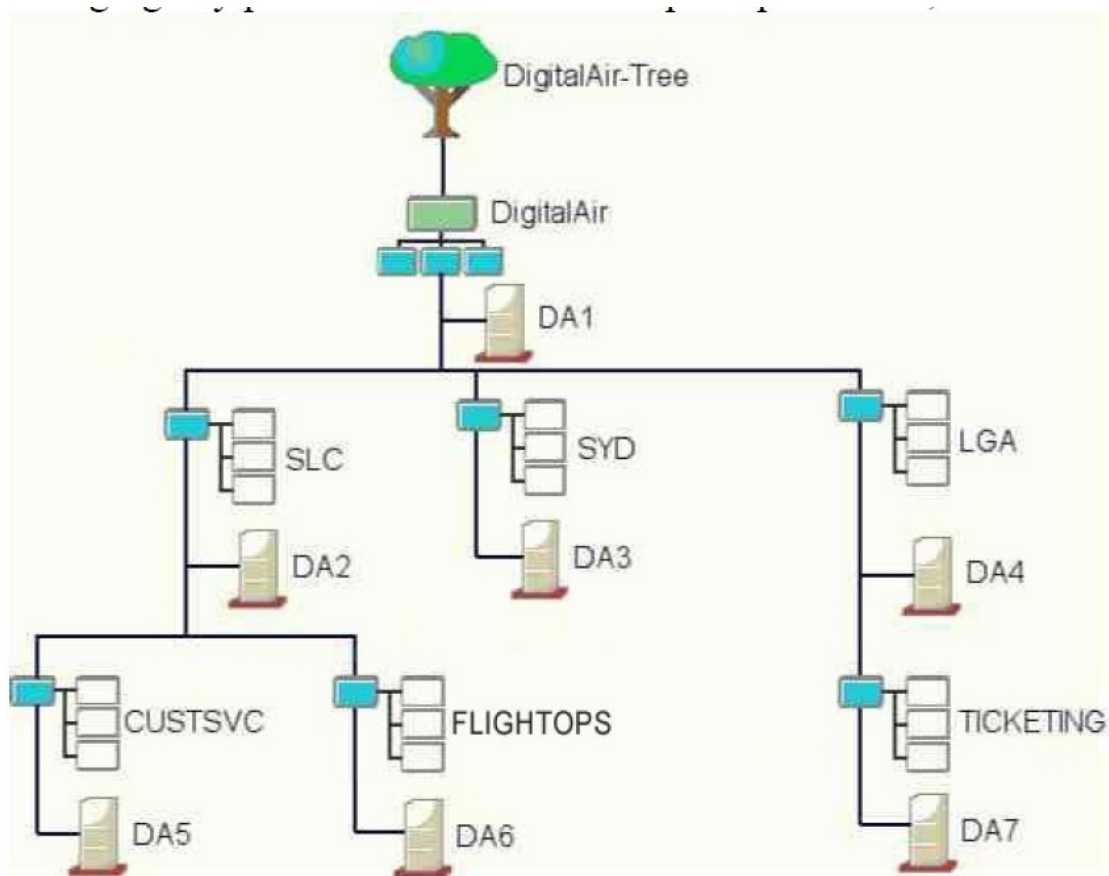

changing any partition boundaries or replica placement, which containers can be moved?

- A. Only the TICKETING container
- B. The SLC, SYD and LGA containers
- C. The SYD, LGA and CUSTSVC containers
- D. All containers except DigitalAir-Tree and DigitalAir
- E. The CUSTSVC, FLIGHTOPS, SYD and TICKETING containers.

Answer: A

2.You are the system administrator for the SLC DigitalAir container. You are creating some new user objects in this container. Which statements are true regarding the eDirectory rights for these new users? (Choose two.)

- A. The rights for the SLC.DigitalAir container has to itself will affect the new users.
- B. The default rights granted to the new users depends on the tool used to create them.
- C. The new users will not have any eDirectory rights unless they are manually assigned.
- D. Tue new users will not have any eDirectory rights unless they are created with a template.
- E. The schema information for the user class will grant the new users some default eDirectory rights.
- F. The new users will not have any eDirectory rights unless they are created with a template or

have rights manually assigned.

Answer: B, F

3. When upgrading your first server to eDirectory 8.7, you may need to update the eDirectory schema. On which server should the schema be updated?

- A. The server you are upgrading to eDirectory 8.7.
- B. The server that has a replica of the [Root] partition.
- C. Any server that holds a replica of any partition of the tree.
- D. A server that holds the master replica of any partition of the tree.

Answer: B

4. Which are default settings for an eDirectory 8.7 tree structure? (Choose 3.)

- A. A Single Organization Unit object is created.
- B. Three Organizational Unit objects are created.
- C. eDirectory keeps the tree as one single partition.
- D. The database is replicated to the first three servers running eDirectory.
- E. The Admin, Server and Volume objects are created as children of [Root].

Answer: A, C, D

5. You are using the eMBox client to log into a server. The information required for login is as follows:

- server's IP address is 10.0.0.1
- port number is 8008
- context for admin is slc.digitalair
- password is novell.

Given this information, what is the appropriate syntax to login from the eMBox client?

- A. login 10.0.0.1:8008; admin.slc.digitalair.novell:
- B. login admin.slc.digitalair:novell 10.0.0.1:8008
- C. login 10.0.0.1:8008 admin.slc.digitalair novell
- D. login 10.0.0.1:8008 -u admin.slc.digitalair -w novell -n
- E. login -s 10.0.0.1 -p 8008 -u admin.slc.digitalair -w novell -n

Answer: E

6. Your eDirectory tree doesn't change often. On average, about once every three months partition changes are made as servers are added to the tree. There are very few additions, deletions or modifications of objects. In general, how often should you perform a health check on this tree?

- A. Once a week
- B. Once a month
- C. Once every three months

- D. Only when partition changes are made
- E. When objects have been added or deleted

Answer: A

7.If a Directory System Agent cannot fulfill a request of a Directory User Agent, which X.500 directory component passes the information to another Directory System Agent?

- A. The Directory Access Protocol
- B. The Directory System Protocol
- C. The Directory Information Tree
- D. The Directory Information Database
- E. The Directory Information Shadowing Protocol

Answer: B

8.Which X.500 Directory component replicates information from one Directory Information Database to another?

- A. The Directory System Agent
- B. The Directory System Protocol
- C. The Directory Access Protocol
- D. The Directory Information Tree
- E. The Directory Information Shadow Protocol

Answer: E

9.Which are true statements when using the eDirectory Backup eMTool to back up and restore Novell eDirectory 8.7? (Choose two.)

- A. You can backup an attribute of just one object.
- B. You can do a quick restore of an individual server.
- C. You must be inside the firewall to do a backup or restore.
- D. You can backup files on the server that are related to the database.
- E. You should not backup your server until eDirectory has been shut down.

Answer: B, D

10.In an eDirectory 8.7 environment, the capabilities of which utilities are included in iManager? (Choose two.)

- A. DSVIEW
- B. DSTRACE
- C. DSMERGE
- D. DSREPAIR
- E. DSBROWSE

Answer: C, D

11.Which statements regarding the extensible match feature of eDirectory 8.7 are true?

(Choose two.)

- A. eDirectory 8.7 currently only supports an exact value match.
- B. eDirectory 8.7 supports matching rules in the extensible match filter.
- C. eDirectory 8.7 allows the inclusion of ACL attributes in a search via the extensible match filter.
- D. eDirectory 8.7 allows the inclusion of the distinguished name attributes in a search via the extensible match filter.
- E. eDirectory 8.7 allows the inclusion of partition-specific attributes in a search via the extensible match filter.

Answer: A D

12.Which Web-based utilities can you use to perform diagnostics and manage eDirectory 8.7?

- A. iMonitor and iManager
- B. iMonitor and Rconsole
- C. iManager and ConsoleOne
- D. iMonitor and Server Console Manager
- E. iManager and Server Console Manager

Answer: A

13.Which aspects of the eDirectory environment are defined by the schema? (Choose 3.)

- A. The steps used to process obituaries
- B. The types of objects that can be created
- C. The number of objects allowed in a partition
- D. The locations an object can exist in the tree
- E. What types of replicas can be held on a server
- F. The total number of replicas that can be held by a server
- G. The information that must be entered and maintained for specific objects

Answer: B, D, G

14.Which aspects of the eDirectory environment are defined by the schema? (Choose 3.)

- A. The roles of different replica types
- B. The syntax of the login script attribute
- C. The steps used to process obituaries
- D. The types of objects that can be created
- E. The information required for an object to exist
- F. The number of associations allowed for an object
- G. The total number of replicas that can exist on a server

Answer: D, E, F

15. You have an eDirectory tree that contains 7 servers. Each server holds replicas as shown in the exhibit. From the information given in the exhibit, which servers will hold a replica of

the schema partition?

- A. All servers
- B. The DA1 server only
- C. All servers except DA7
- D. The DA1, DA2 and DA6 servers only

Answer: A

16. You have an eDirectory tree that contains 7 servers. Each server holds replicas as shown in the exhibit. From the information given in the exhibit, which servers can you use to make modifications to the schema partition?

PARTITIONS	SERVERS						
	DA1	DA2	DA3	DA4	DA5	DA6	DA7
DigitalAir-Tree	Master	R/W				R/W	
DigitalAir	Master	Sub Ref	R/W		R/W	Sub Ref	
SYD.DigitalAir	Master		R/W	R/W	Sub Ref		
LGA.DigitalAir	Master	R/W	Sub Ref	R/W	Sub Ref		
CUSTSVC.SLC.DigitalAir	Master	R/W	Sub Ref		R/W		

- A. All servers
- B. The DA1 server only
- C. All servers except DA7
- D. The DA1, DA2 and DA6 servers only

Answer: D

17. The DA3 server is preparing to synchronize schema. What servers will DA3 send schema synchronization information to?

- A. Only servers in DA3's poll list
- B. All servers in the same tree as DA3
- C. All servers sharing replica rings with DA3
- D. Only servers in replica rings where DA3 is the Master

Answer: D

18. Which utilities can be used to view the schema synchronization process? (Choose two.)

- A. iMonitor
- B. iManager
- C. ConsoleOne
- D. MONITOR.NLM
- E. DSTRACE.NLM

Answer: A, E

19. You created a new application object in the SLC.DigitalAir partition. After creating the

object you noticed a problem when running a health check. Using the information in the exhibits, what is the best solution to try first?

- A. Reset schema on the DA1 server.
- B. Reset schema on the DA2 server.
- C. Remove all replicas from the DA1 server.
- D. Remove all replicas from the DA2 server.
- E. Declare a new epoch on the Schema partition.
- F. Remove eDirectory from the DA1 server and re-install.
- G. Remove eDirectory from the DA2 server and re-install.

Answer: D

20. Performing which partition operation will never cause the number of real objects in any server's eDirectory database to change?

- A. Move
- B. Merge
- C. Create
- D. Add Replica
- E. Remove Replica

Answer: B

21. Which statements are true regarding replica types? (Choose two.)

- A. Subordinate references contain only the partition root object.
- B. Master and read/write replicas are the only replicas that are automatically created.
- C. A master or read/write replica must reside on a server where bindery services is used.
- D. Subordinate references can be promoted to be the master replica without causing problems to the NDS tree.
- E. Master, read/write, read-only, and subordinate reference replicas can be manually created by the network administrator.

Answer: A, C

22. Which statements are true regarding replica types? (Choose two.)

- A. The master replica controls the obituary process through the janitor process.
- B. Master, read/write, and read-only replicas control partition boundary changes.
- C. Master, read/write, and read-only replicas control creating, deleting, and moving objects.
- D. The subordinate reference replica is the only replica that cannot be manually created by the network administrator.
- E. Master, read/write, read-only, and subordinate references contain a complete copy of all object information of the partition.

Answer: A, D

23.Which replica type can fill original requests for object changes but passes off all partition requests?

- A. Master
- B. Read/write
- C. Read-only
- D. Subordinate reference

Answer: B

24.Which replica type contains only the partition root object?

- A. Master
- B. Read/write
- C. Read-only
- D. Filtered replica
- E. Subordinate reference

Answer: E

25.Which replica or replicas contain a complete copy of all object information of a partition?

- A. Master
- B. Master and read-only
- C. Master and read/write
- D. Master, read/write, and read-only
- E. Master, read/write, read-only, and subordinate reference

Answer: D

26.Which statements are true regarding subordinate reference replicas? (Choose two.)

- A. There can be multiple subordinate references per partition.
- B. Subordinate references must reside on every server in the tree.
- C. Subordinate references link a parent partition with its child partition.
- D. A subordinate reference can be changed to be a master replica without losing information.
- E. Subordinate references should be removed to help reduce traffic across the communication channel.

Answer: A C

27.Which statements are true regarding subordinate reference replicas? (Choose two.)

- A. Subordinate references only contain the partition root object.
- B. Subordinate references link a parent partition with its child partition.
- C. Subordinate references can be manually created by the administrator.
- D. A subordinate reference can be changed to be a master replica without losing information.
- E. Subordinate references should be removed to help reduce traffic across the communication

channel.

Answer: A, B

28. Which statements are true regarding transitive synchronization? (Choose two.)

- A. The transitive vector attribute is not a synchronized attribute.
- B. Transitive synchronization updates replicas in a sequential order.
- C. The transitive vector attribute is located on any partition root object.
- D. Transitive synchronization does not require a server to be able to talk with every server in the replica ring.
- E. Transitive synchronization allows subordinate references to participate in a normal replica synchronization.

Answer: C, D

29. When a non-local object authenticates or attaches to a server, eDirectory creates a placeholder for this object. What is this placeholder called?

- A. Backlink
- B. Obituary
- C. Attribute
- D. Remote object
- E. External reference

Answer: E

30. RThomas is logging in to the DA4 server. The DA4 server does not hold a replica of the partition where RThomas' user object exists. An external reference is created on the DA4 server containing information about RThomas user object. On the server with a replica of the partition containing RThomas eDirectory also attempts to create an attribute pointing to the DA4 server.

What is the name of this attribute?

- A. Janitor
- B. Obituary
- C. Backlink
- D. Flat cleaner
- E. External reference

Answer: C